



Contents

Defense

Man	2
Zone - 1-3-1 half court trap	3
Zone - 2-3	4
Junk - match 1	5

Offense

4 out - zone	6
Hilo even zone	8
Hilo man 1	11
Hilo man 2	13
Hilo man 2, 5 fronted	14
Hilo man 3	16
Hilo man 4	18
Hilo odd zone	20
Hilo variations	22
Star	25

Inbounds

Box 1	26
Box 2	27
Sideline 1	28
Sideline 2	29
Stack 1	30
Stack 2	31
Stack 3	32
Triangle	33

Special

Opponent free throw	34
---------------------	----



Man

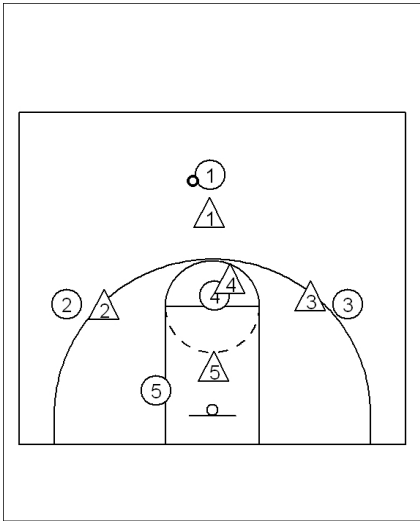

Man defense
Name - 10 defense

This defense is designed to stop the ball, defend players who are one pass away from the ball, and help on the "most important man" or MIM.

In this diagram, 1 defends against the ball. The defender on the ball must stay between his opponent and the basket.

Since offensive player 2, 3, and 4 are one pass away, defenders 2, 3, and 4 protect against passing lane.

Since offensive player 5 is two passes away, defender 5 remains close but is in position to help with MIM (player with ball).

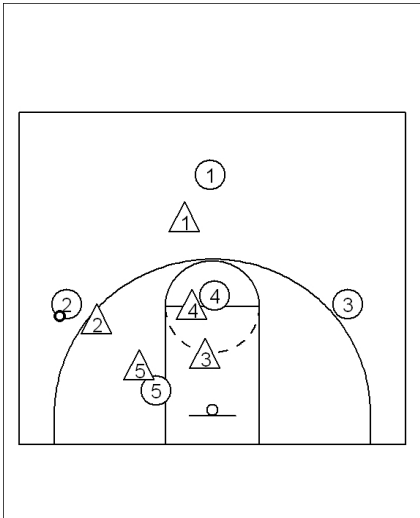

With ball on the wing, 2 becomes defender on the ball.

Offensive players 1, 4, and 5 are one pass away and defenders should play the passing lane.

Offensive player 3 is two passes away so defender 3 moves to middle of court to help on MIM.



Zone - 1-3-1 half court trap

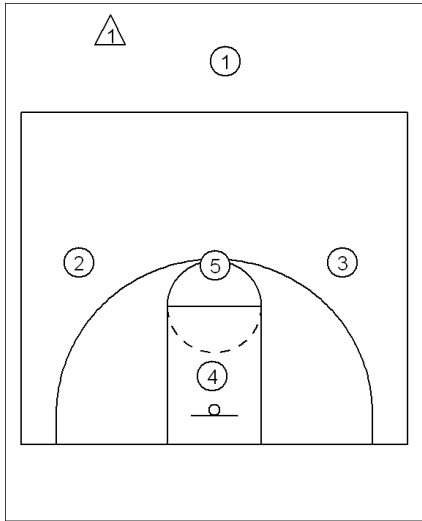

Zone 1-3-1 half court trap

Primary goal is to force turnovers using traps (double team opponent) to force 5 second violations or weak passes

Players who trap an opponent **MUST NOT COMMIT FOULS**. Players should stand straight with hands in air attempting to deflect a pass and should not reach for the ball unless it is loose on the floor

Players must sprint on passes. 5 remains in the key. 4 runs the baseline. 1, 2, and 3 sprint to traps or look to jump passing lanes

1 picks up dribbler at top of opposite key and forces dribbler to one side. (Note - in grades 4-6, 1 cannot pick up until half court but the same principles apply.)

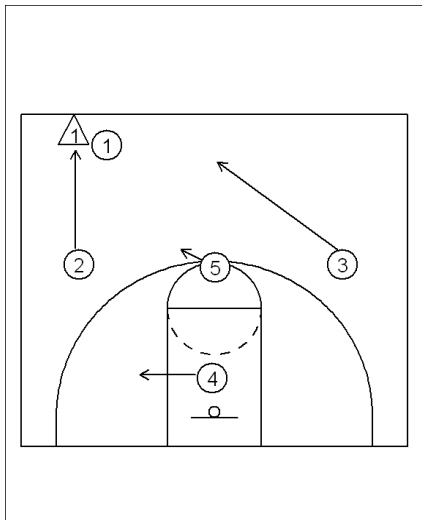

As opponent crosses half court, 2 sprints to trap opponent with 1

3 sprints to cut off passing lane across court

5 protects against entry to high post

4 protects against pass to corner or sprints against any long, cross court pass

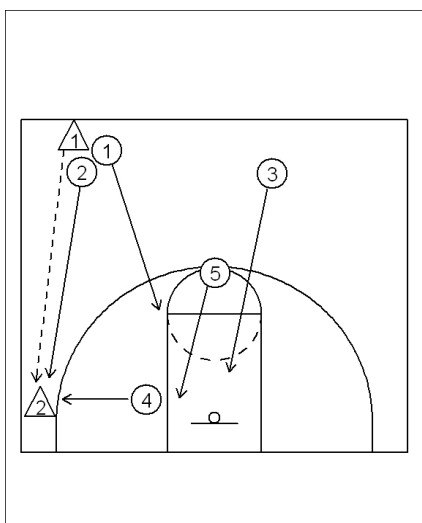

If ball moves to corner or wing, 2 and 4 trap ball

5 sprints to protect low post area

3 sprints to protect against cross court pass

1 sprints to protect high post area

Continue trapping with closest two defenders from original positions and protecting with other 3 defenders



Zone - 2-3

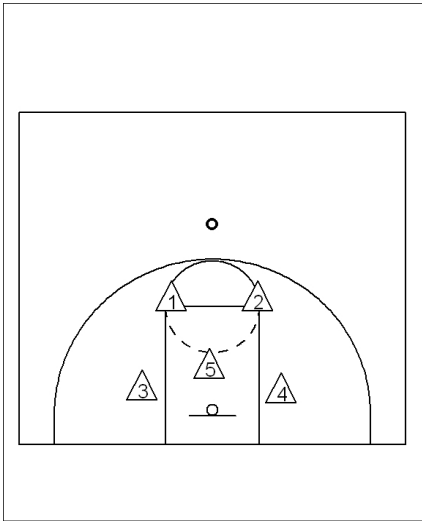

Name - 20 defense

Variations - 21 (see junk defenses, match 1), 22 (see junk defenses, match 2), 25 (trap after pass to wing)

Standard 2-3 alignment shown

This defense is designed to force outside shots from the opponent. It is a more passive defense that allows the ball to be passed around the perimeter. Players should stay close to the key.

1 and 2 cannot allow dribble penetration in middle or an entry pass to the high post

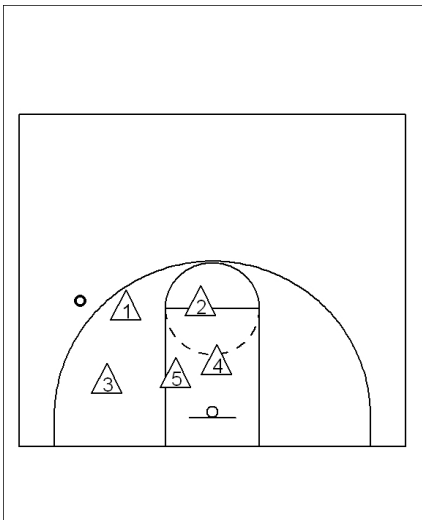

When ball is in the wing, the zone shifts to that side.

2 and 4 (backside defenders) should be even with the basket, with 4 slightly higher than original position

5 slides to ball side

1 slides toward ball but remains tight

3 slides toward ball but remains tight

Reverse alignment if ball is on other wing

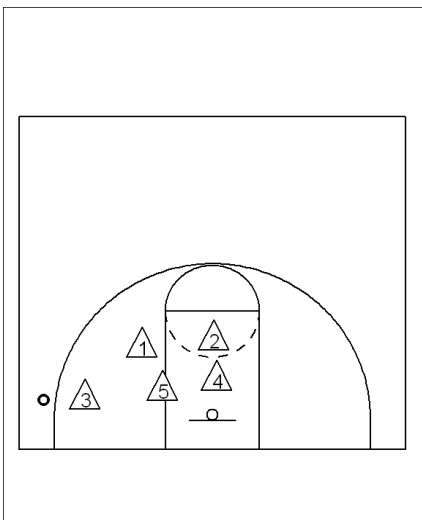

With ball in corner, zone shifts more to that side.

1 and 2 play below foul line

2 and 4 remain even with basket

5 protects ball side block



Junk - match 1

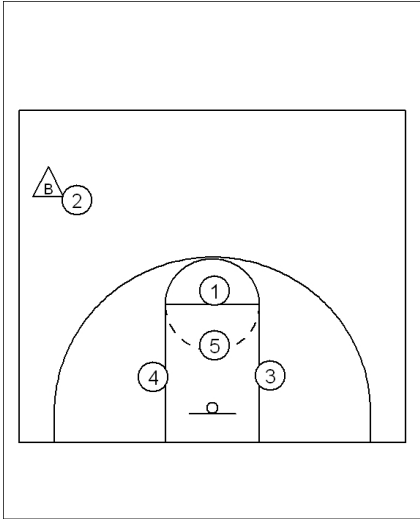

Junk - Match 1

This defense is designed to stop 1 good player.

2 (might be 1) is assigned task to face guard opponent's best player (B). 2 tries to prevent B from catching the ball. If B catches ball, 2 plays off of B to prevent a drive without fouling (DO NOT REACH). If 2 gets beat off dribble, zone reacts and 2 recovers

The remainder of the defense plays a 2-1-2 zone where 1 moves to ball side at all times



4 out - zone

Standard 4 out set

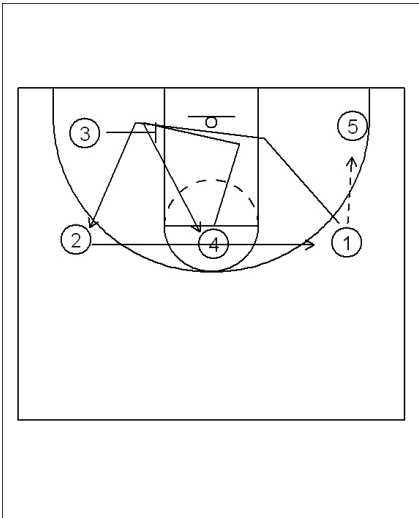
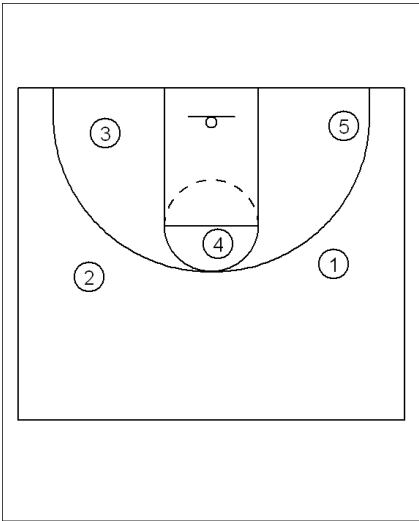

1 passes to 5, cuts to basket looking for return pass and layup. If no return pass, 1 sets quick pick in lane for 4 (especially vs 2-3 zone) and then fills top right corner

2 fills top left corner

3 comes to block to have 1 and 4 cut around

4 follows 1's cut, looking for pass and layup. If no pass, 4 returns to original spot

5 receives pass from 1 and looks for pass to 1 or 4 for layups

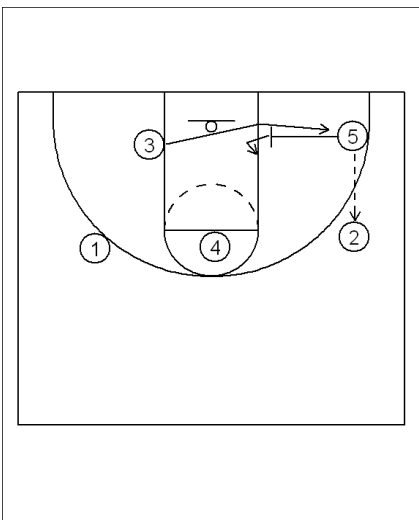

5 passes to 2, comes to block to set pick for 3, and then posts up looking for entry pass

3 waits for pick by 5 and then proceeds around pick to short corner

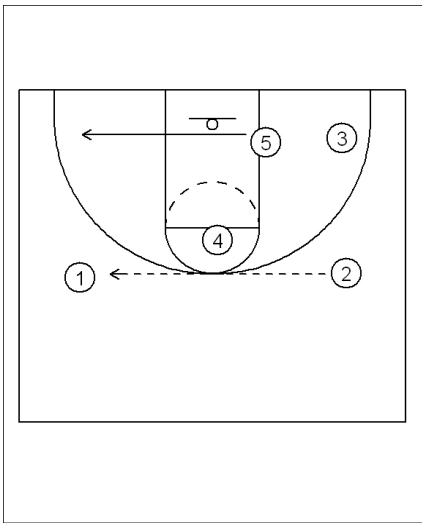

If nothing is open, 2 crosses the ball to 1

5 crosses to opposite short corner

Run same sequence from opposite side



Hilo even zone

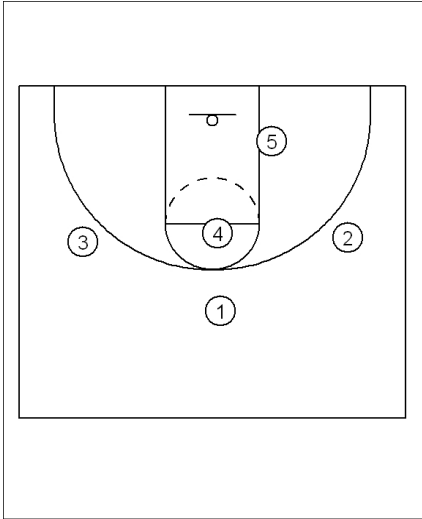

Basic set

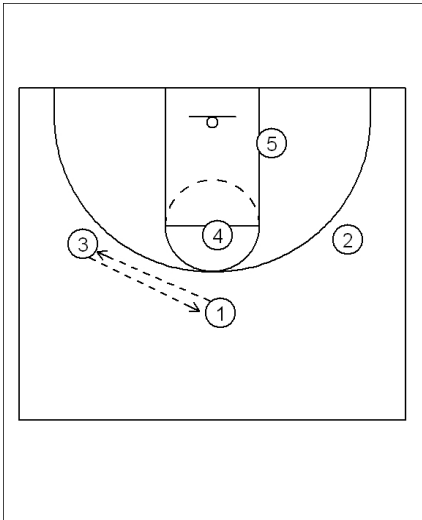

Begin movement of zone
1 passes to 3
3 returns ball to 1

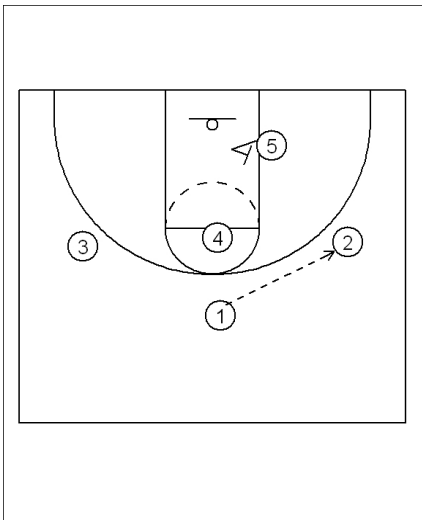

1 passes to 2
As the ball goes from 1 to 2, 5 steps into paint posts up middle defender
2 looks to pass to 5

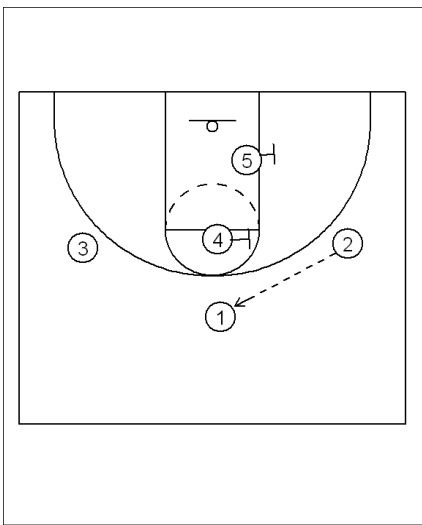

if 2 cannot pass to 5, 2 reverses the ball to 1

as the ball moves from 2 to 1, 5 posts up lower wing and 4 posts up guard

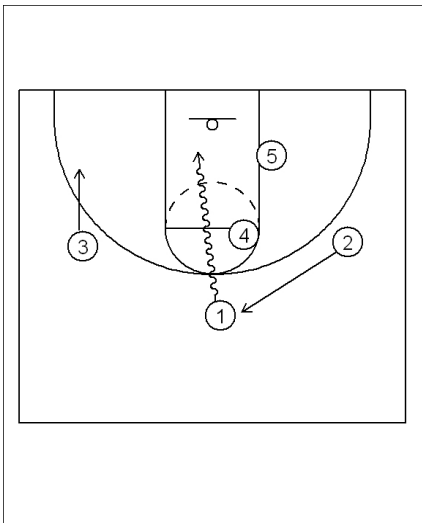

1 splits guards as 3 slides lower and 2 rotates to the top of the formation

1 looks for layup, dish to 5, then outlet to 3

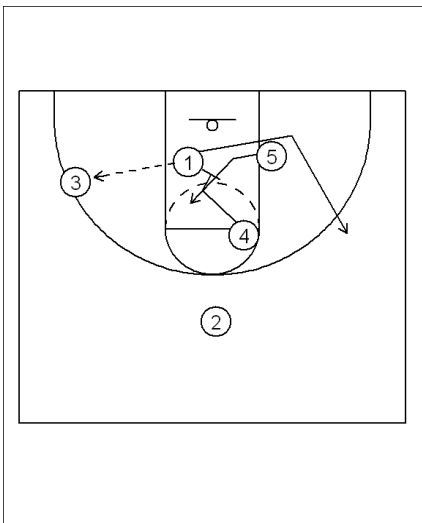

if 1 kicks to 3, 1 fills right wing

4 picks down on middle defender and 5 flashes high

3 looks to feed 5

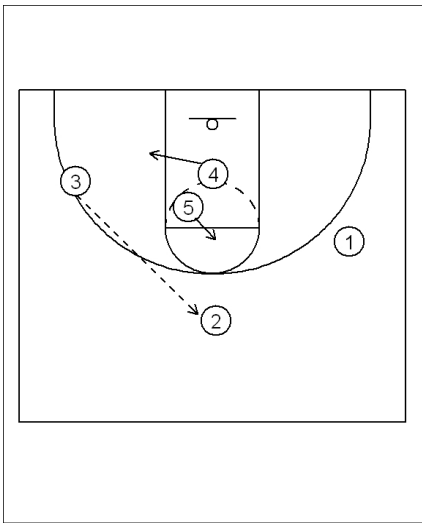

if 3 cannot feed 5, 3 returns the ball to the top to 2

4 goes to low post, 5 to the hi post

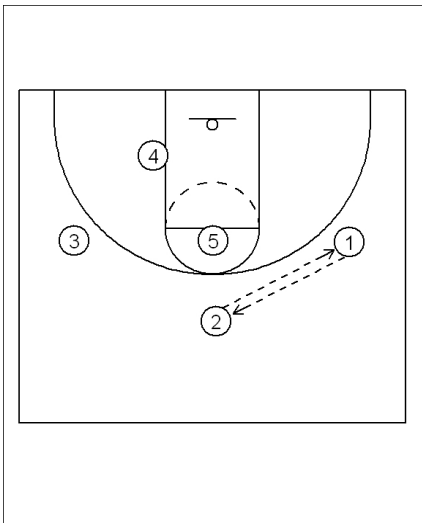

start the play over from the other side



Hilo man 1

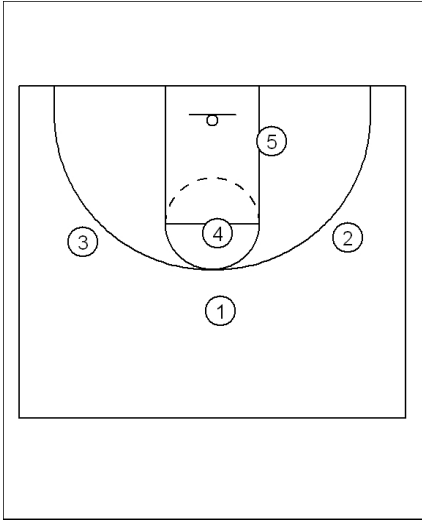

basic set

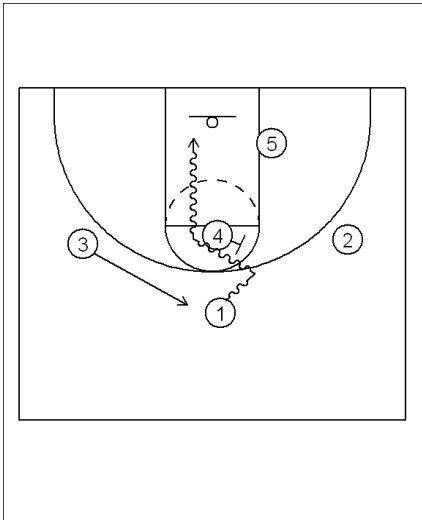

4 sets pick for 1

1 goes right, crosses over to use pick, and drives the lane

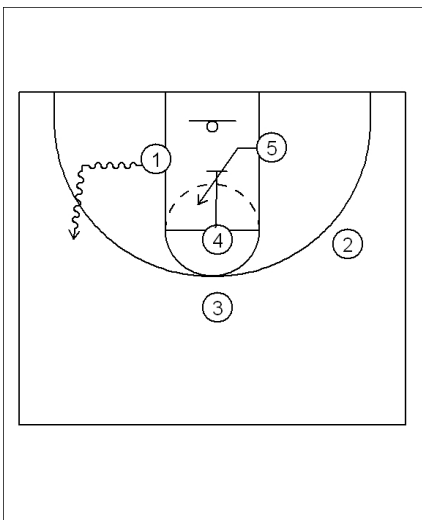

if 1 is stopped and cannot pass to 5 for layup, 1 dribbles out and looks for interior pass

4 sets down pick for 5 and then continues to low post, and 5 flashes hi looking for ball

if 1 cannot pass to posts, 1 passes to 3 and begin process again

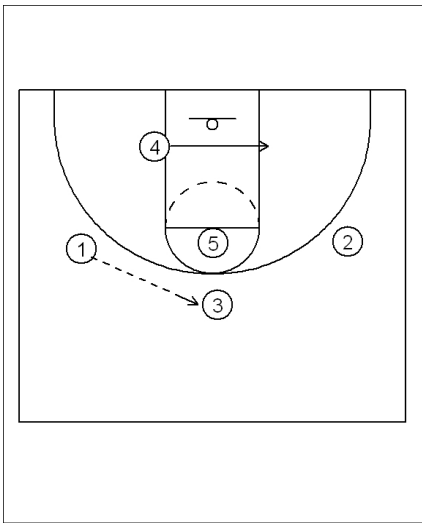

if 1 cannot pass to posts, 1 passes to 3

4 moves to starting block

begin another sequence



Hilo man 2

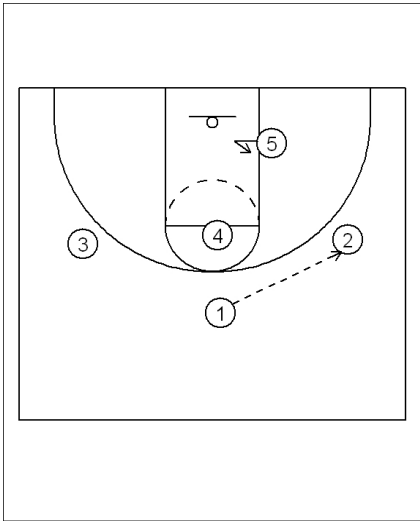

1 passes to 2

5 posts up defender

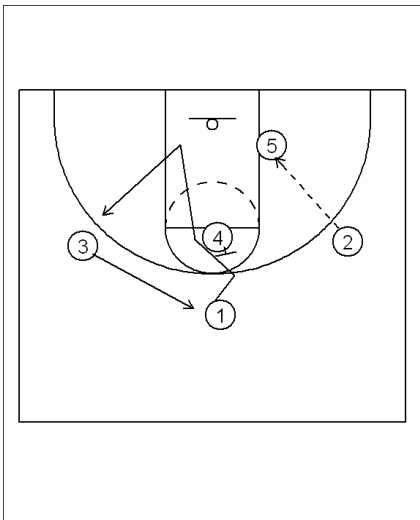

2 passes ball to 5 if 5 is not fronted by defender

when 5 receives ball, 4 sets pick for 1 who drives the lane

5 looks for 1 cutting and then runs post moves



Hilo man 2, 5 fronted

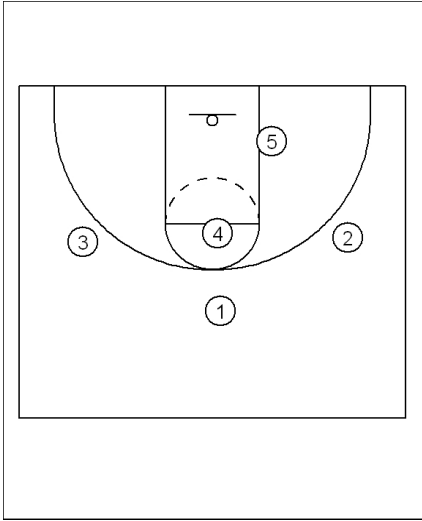

basic set

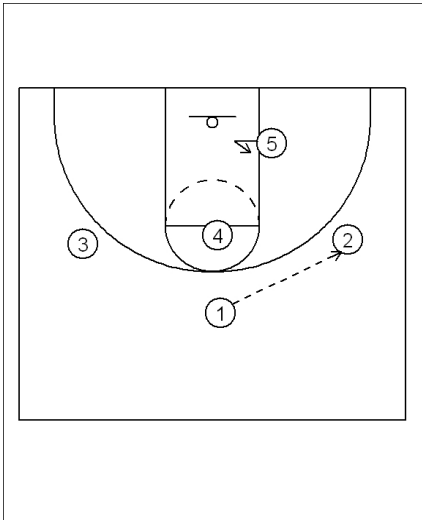

1 passes to 2
5 posts up defender

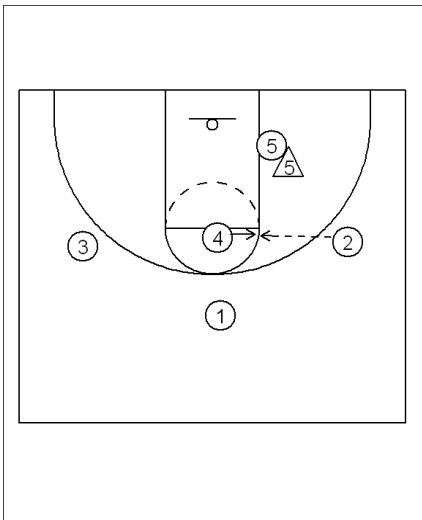

if 5 is fronted by defender, 4 slides to elbow
2 passes to 4

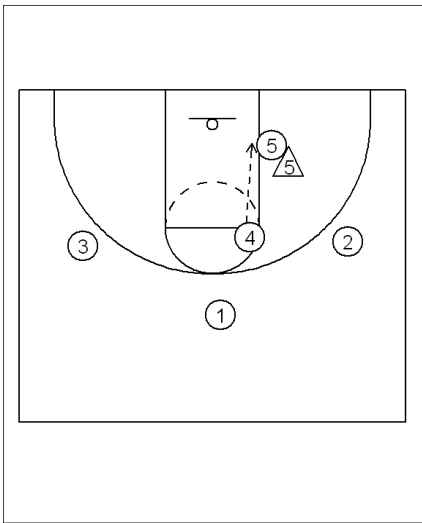

5 keeps defender outside

4 passes to 5



Hilo man 3

basic set

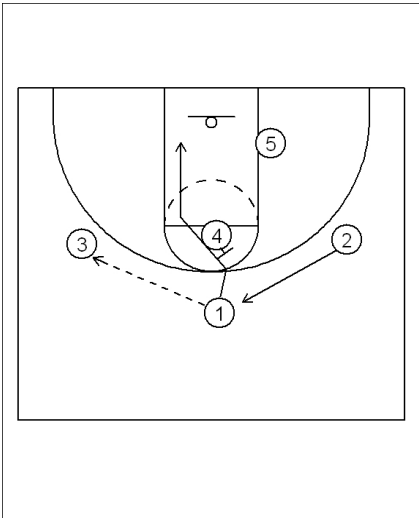
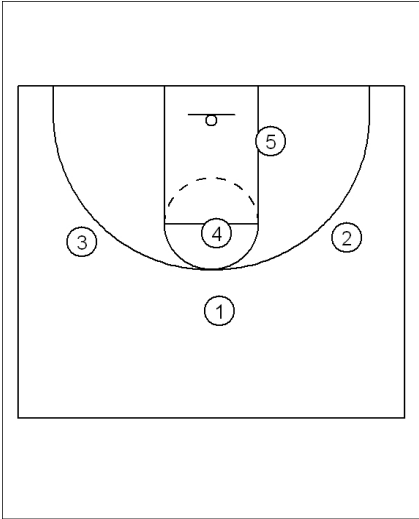

1 passes to 3
4 sets pick for 1
1 drives lane looking for pass
2 fills top

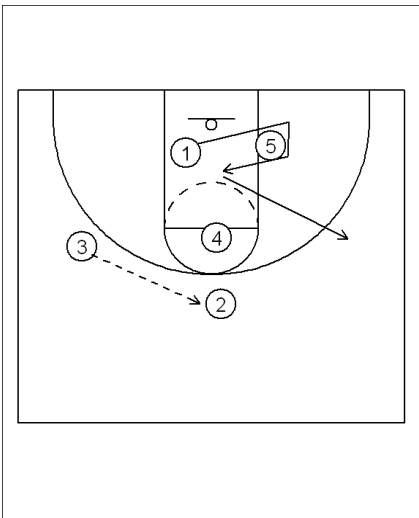

if 3 cannot pass to 1, 1 curls around 5 and reenters lane looking for pass
if 3 cannot pass to 1, 1 fills opposite wing
3 passes to 2

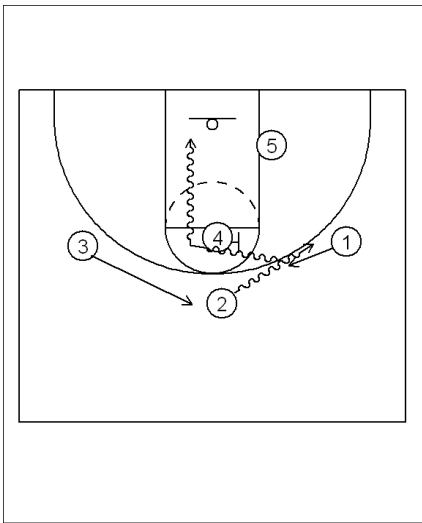

2 dribbles toward 1's defender to pick defender

1 moves toward two

2 hands ball to 1 on outside

4 sets pick for 1

1 dribbles around pick and down the lane

3 fills top spot



Hilo man 4

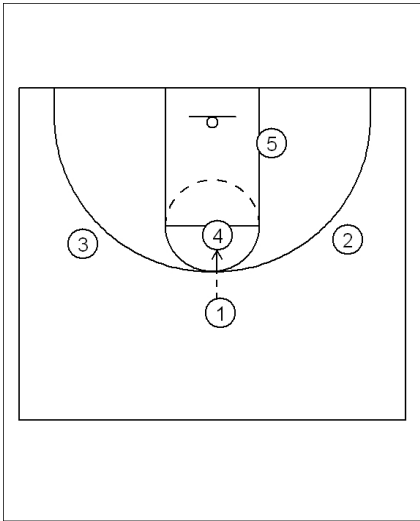

1 passes to 4

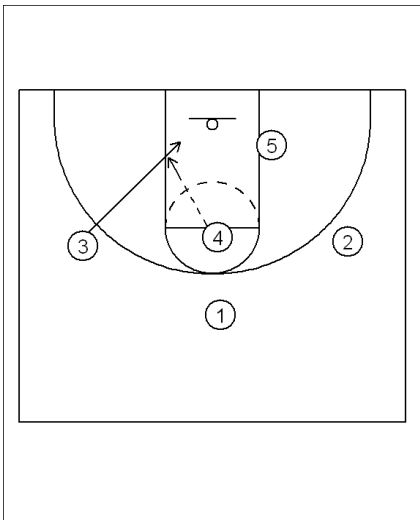

3 cuts behind defender looking for layup

4 passes to 3

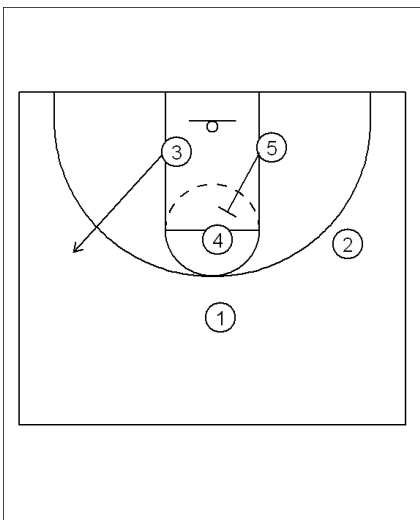

if 4 cannot pass to 3, 3 returns to wing

5 sets pick for 4

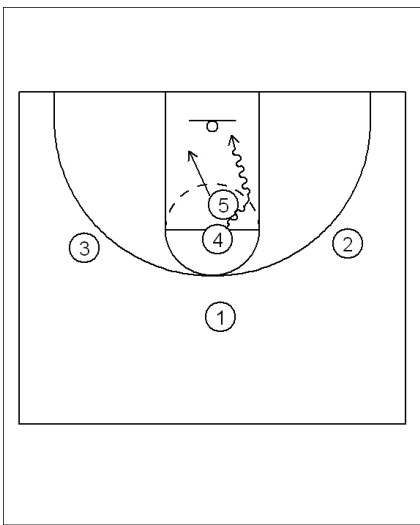

4 and 5 run pick and roll

4 dribbles down lane over the pick looking for layup

5 turns and goes toward opposite side of basket

if defender takes 4, 4 passes to 5 for layup

if nothing is open, 4 returns ball to wing and players reset



Hilo odd zone

basic set vs odd zone

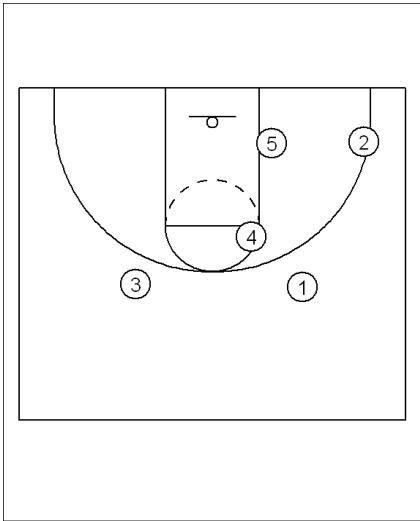

1 passes to 2

5 steps into lane and posts up middle defender

2 looks to feed 5, then looks to 4

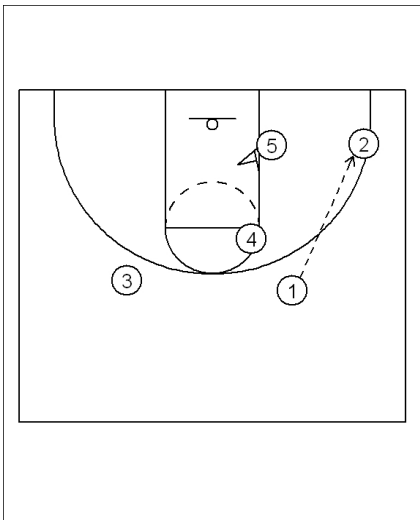

if 2 cannot pass to posts, 2 returns the ball to 1

2 runs the baseline to the corner position on the other side of the court

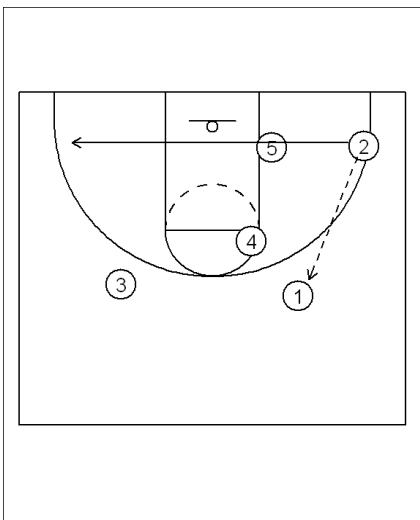

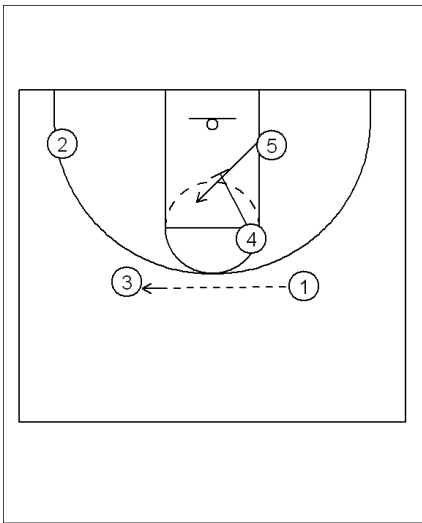

1 passes the ball to 3

4 picks down for 5 and then continues to the opposite low post

5 flashes around pick looking for pass and then continues to the opposite hi post

3 looks to feed 5 and then 4

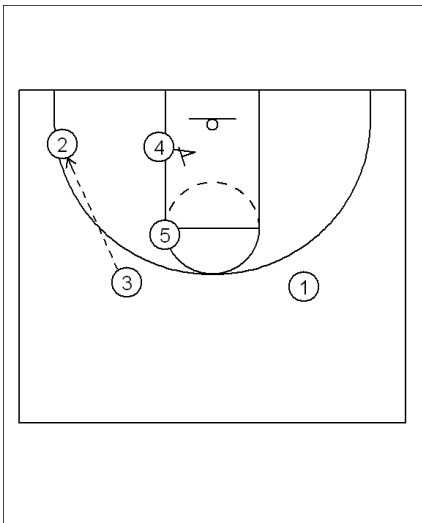

if 3 cannot make entry pass to posts, 3 feeds to 2

2 looks for entry to 4, and then looks for 5

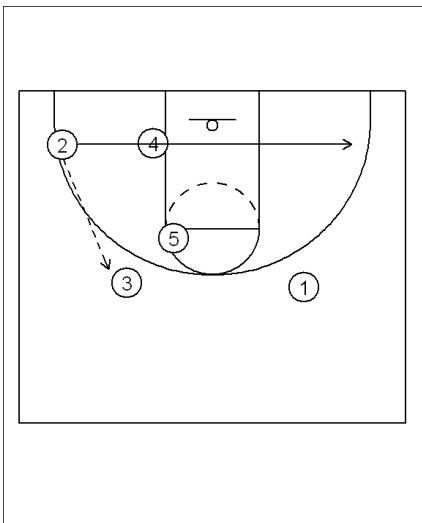

if 2 cannot pass the ball to the posts, 2 passes to 3

2 runs baseline to opposite corner

continue pattern



Hilo variations

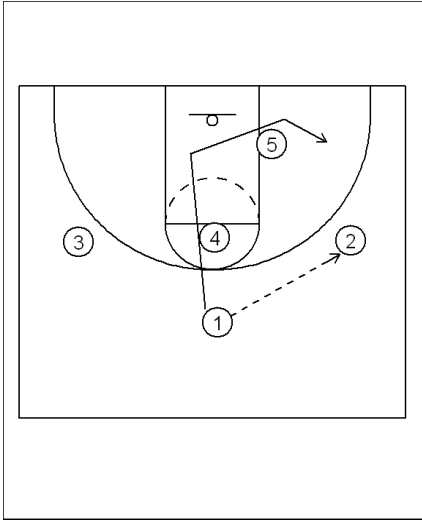

Curl

Creates shot for 1 in the short corner, possible pass to 5

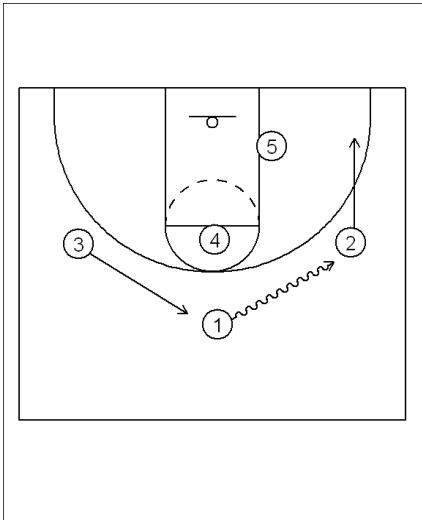

Slide right

Creates overload on one side

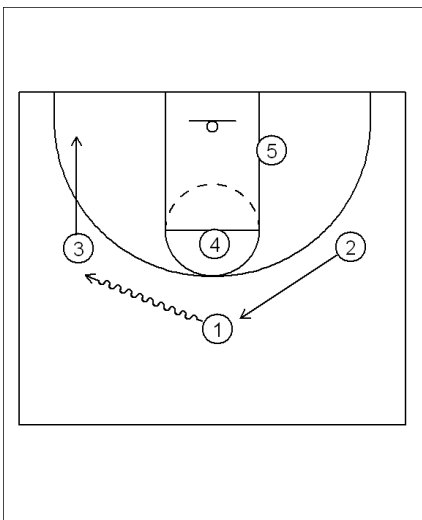

Slide left

Creates overload on side

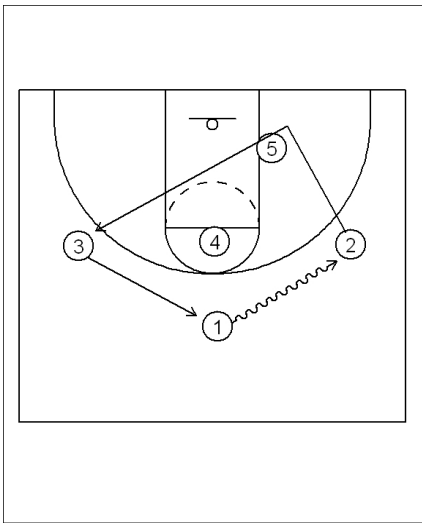

Counter (clockwise rotation)

Moves 1 to wing for different look

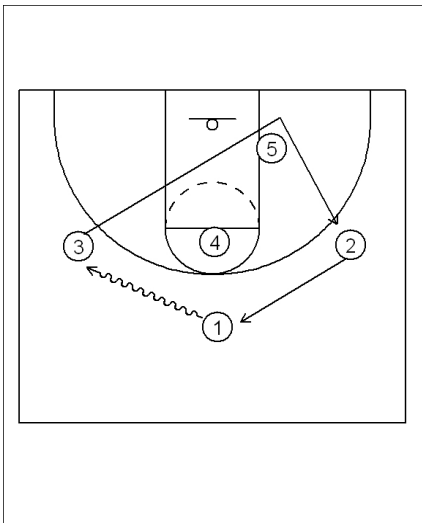

Clock(wise rotation)

Moves 1 to wing for different look

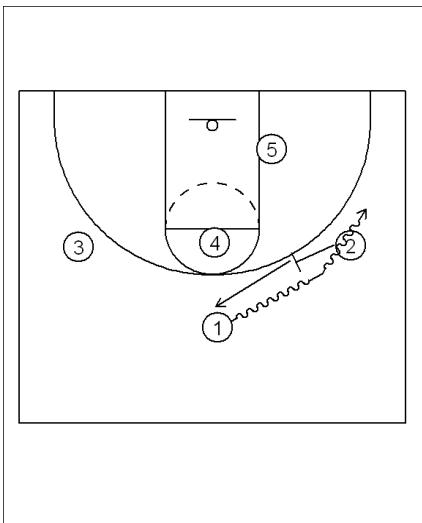

Seal right

2 sets pick against man covering 1 or against top of the zone, then rotates to top

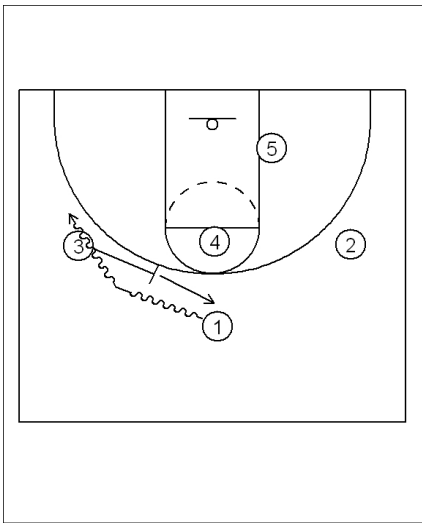

Seal left

3 sets pick against man covering 1 or against top of the zone, then rotates to top



Star

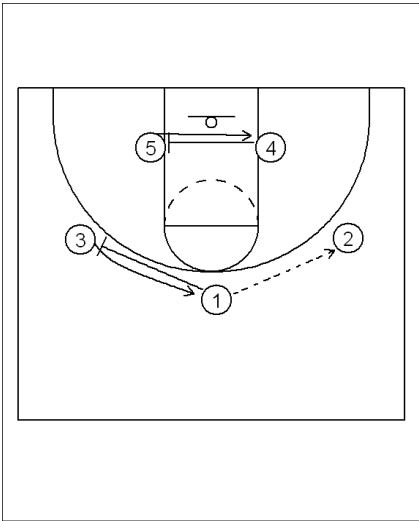

Basic pass and screen away offense. The passer and the player closest to the pass receiver must screen away. Players must wait for the screen to be set before using the screen.

- 1 passes to 2
- 1 screens away for 3
- 4 screens away for 5
- 2 must look for 5 immediately

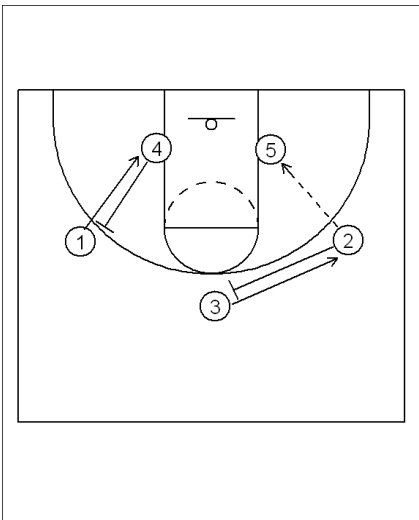

- In this case, 2 passes to 5
- 2 and 4 screen away
- 5 looks to score or to feed 1 for layup

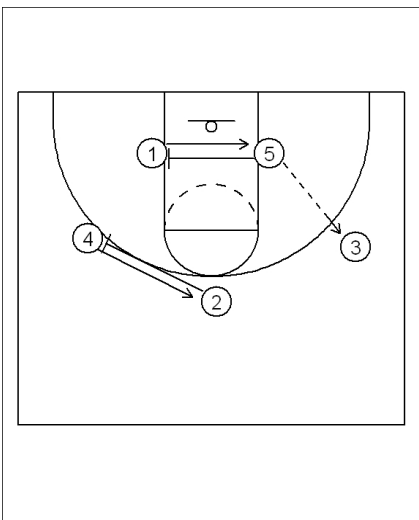

- If 5 returns ball to 3, 5 and 2 screen away
- 3 looks for 1 immediately
- Continue to pass, screen, and look for easy basket
- Note - on a defensive switch, screener should return to the ball



Box 1

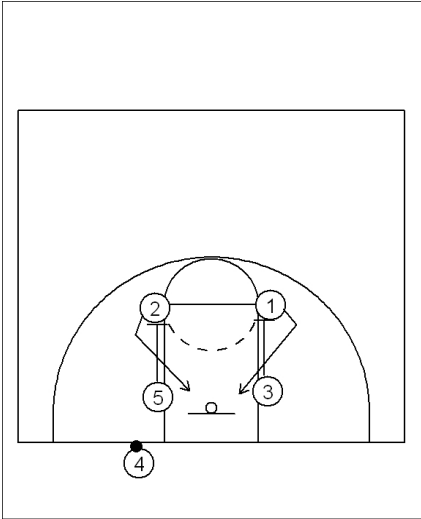

Alignment - box at elbows and blocks

Use vs man.

3 and 5 go to foul line to set picks

2 and 1 use pick and cut for layup

4 looks for 1, then 2

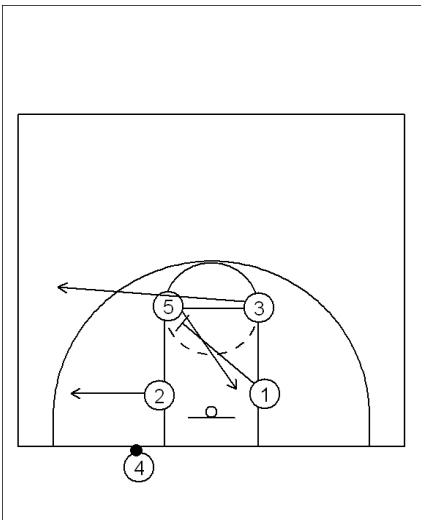

If no layup, 1 picks for 5

2 and 3 become outlets

4 looks for 5, then 2 or 3



Box 2

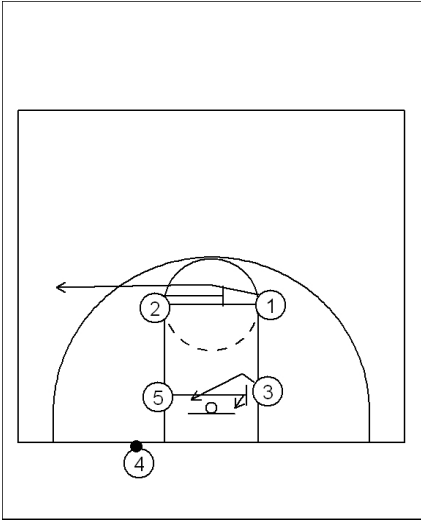

Alignment - box at elbows and blocks

Use vs man or zone. This play should be run if box 1 has been run at least once.

2 and 5 cross lane to set picks

3 crosses for layup

1 crosses to wing for an outlet

4 looks for 3, then 5, then 1



Sideline 1

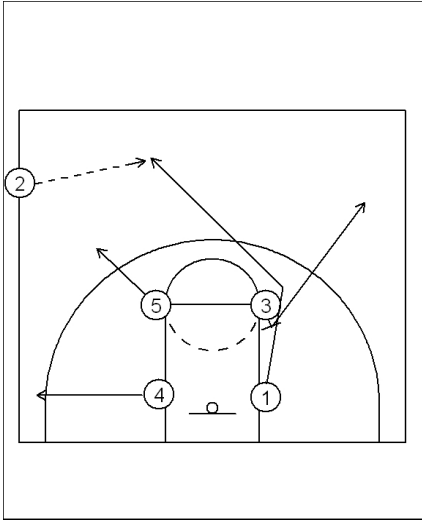

Box formation as shown. 5 and 4 always will be closest to 2

3 sets pick for 1 and then fades to far side

1 uses pick and comes toward ball

5 moves toward ball

4 goes to corner

2 looks to get ball to 1, then looks to other options



Sideline 2

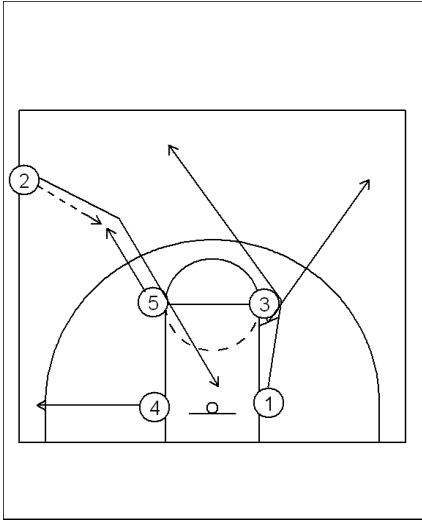

Same cuts as Sideline 1

2 passes to 5.

On pass, 2 breaks toward 5 for handoff and layup



Stack 1

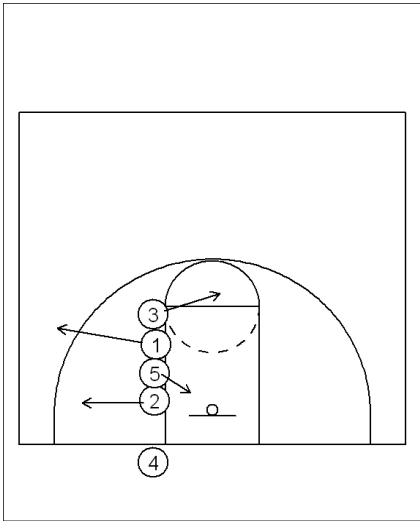

Use against - zone or man

Purpose - spread defense to create opportunity off of the inbound

Description - players stack as shown. 4 hits ball and players break. Idea is to form a box that is difficult to defend. Players must have good separation to spread the defense.

4 looks first for 5 for easy layup.

If 5 is not open, 4 looks for 1 then 2 then 3.

With proper separation vs a zone, one person must be open. With proper spacing vs man, easy entry pass to 5.

After pass, 4 enters court on opposite side of entry pass (creates rebound opportunity).

If pass does not go to 5, reset to standard offense unless easy shot is available.



Stack 2

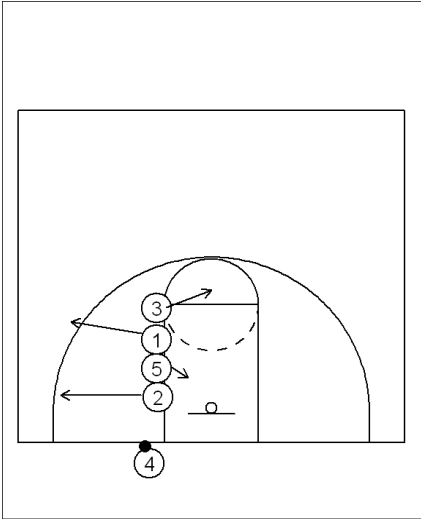

Use vs - man or zone. This variation is more for man.

This play runs stack 1 and then runs the box move.

4 slaps ball to begin play.

1 and 2 break toward sideline. 3 and 5 break toward key. If 5 is open, pass for layup.

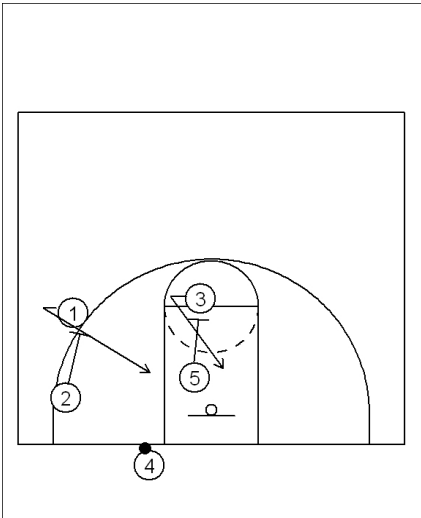

If 5 is not open, run box.

1 picks up for 2. 5 picks up for 3. 2 and 3 jab toward sideline and cut off pick.

1 and 5 roll toward sideline as outlets.



Stack 3

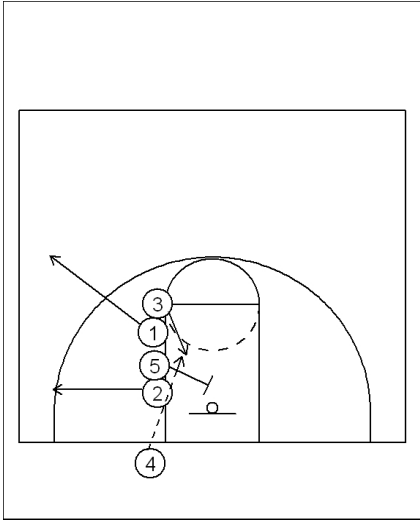

4 inbounds ball

2 goes to corner

5 picks down on defender in middle

1 cuts to top left corner

3 cuts down looking for lob and short jumper



Triangle

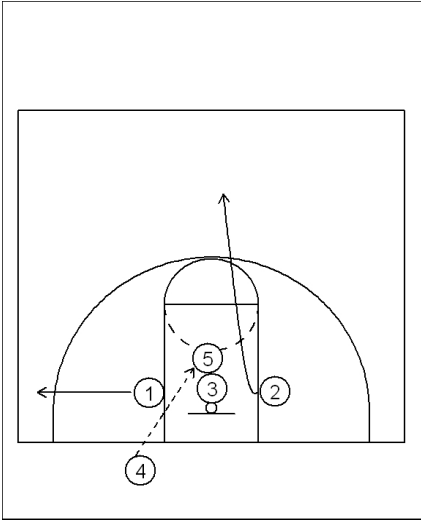

Triangle (vs zone)

4 lobs ball high to 5

5 catches ball above head, shoots from above head

2 looks for back door then heads to top of key

3 looks for direct pass for layup



Opponent free throw

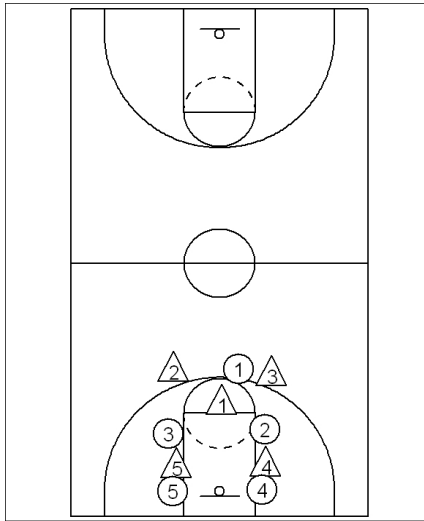

Fast break off of an opponent's free throw

Align as shown.

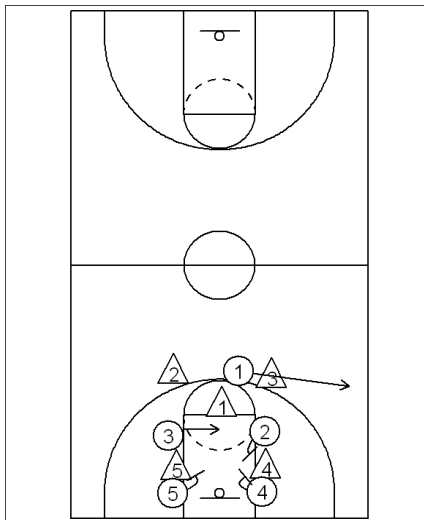

4 blocks out and 2 pinches down

5 blocks out

3 blocks out shooter

1 moves toward sideline above foul line

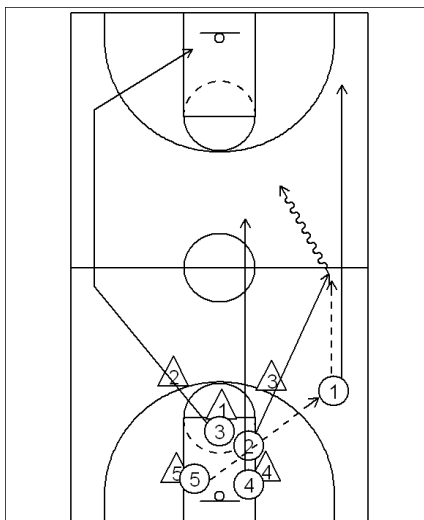

On rebound or made shot, 2 releases to half court

3 releases to left sideline and runs court, cutting in at foul line

Rebound is passed to 1

1 looks for 2 at midcourt, then trails on right sideline

2 dribbles toward right elbow and can penetrate or pass to 3 for layup